

INTELLIGENT SYSTEMS: A SEMIOTIC PERSPECTIVE

ALEXANDER M. MEYSTELE

*National Institute of Science and Technology**
Building 220 Room B124,
Gaithersburg, Maryland, 20899-0001, USA

Intelligent systems have been in the focus of attention of the scientific community for a long time. Nevertheless, the concept of *intelligent system* is not fully understood, and it affects interpretation of the existing research results as well as the choice of new research directions. In this paper, the subject is considered from the semiotic point of view. The phenomenon of intelligence is demonstrated as a result of joint functioning of three operators: Grouping, Focusing Attention, and Combinatorial Search (GFACS). When information is processed by GFACS, the multiresolutional systems of knowledge develop, and nested loops of knowledge processing emerge. This conceptual structure allows for explaining most of the processes characteristic of intelligent systems. The emphasis of this paper is on demonstrating that the nature of intelligent systems is revealed the best, and the means of controlling them are introduced in the most constructive way when the theoretical tools of semiotics are applied.

Keywords: Baby-robot, Combinatorial search, Focusing attention, Generalized subsistence machine, GFACS, Goal directed functioning, Grouping hierarchies, Imagination, Intellect, Intelligence, Intelligent system, Interpretation, Multiresolutional (Systems), Pragmatics, Reflection, Regular subsistence functioning, Representation, Resolution (of Representation), Semantics, Semiosis, Semiotics, Six-box diagram, Syntax, World model.

1. Introduction

The intention of this paper is to review the present situation in the area of intelligent systems including their analysis, design, and control, in order to clarify the status of concepts frequently utilized and to outline a sketch of a theory of intelligent systems based upon approaches from applied semiotics. The body of knowledge in this area can be characterized by many very diverse approaches presented in several excellent books,¹⁻⁴ conceptual papers⁵⁻⁷ and numerous sources in cognitive science and artificial intelligence.⁸⁻⁹ Knowledge of these sources can be helpful for understanding, but it is not a prerequisite for reading this paper.

The peculiarity of the present situation is that we rather have an abundance of diverse answers to a set of questions which have not yet been formulated

in an organized fashion. We will try to raise these questions and to propose our answers in this paper. In all cases, the analysis ascends to a symbolic system which is supposed to be a carrier of intelligence no matter which particular model is selected by a researcher. This is why semiotics can be recommended as a natural framework, an invariance to the whole area of intelligent systems.

Semiotics is a science of dealing with symbolic systems. It provides definitions and formal techniques applicable to a wide variety of fields including natural language disciplines (literature, linguistics, etc.), science (physics, chemistry, biology, etc.), disciplines of a formal modeling (mathematics, logic, etc.), engineering sciences, etc. The background of semiotics was precipitated during the last two thousand years. As a discipline, it was first presented in a complete form by C. Peirce in the middle of the last century.^{10,11} It was developed in depth during XIX

*On Sabbatical from Drexel University

and XX centuries by many scholars working in different countries. Substantial contribution in semiotics was made by Russian scientists.^a (See a condensed synopsis of the semiotics evolution in Ref. 12.)

Nevertheless, the recorded milestones of the process of development of the semiotics related to intelligent systems, are related to USA. The first meeting on Artificial Intelligence was conducted in 1956 in Dartmouth College, the first meeting on self-organizing systems — in May, 1959 in Illinois Institute of Technology (Chicago, IL); the multivolume publication on cybernetics and brain functions was completed in the late sixties. The monographs on hierarchical and other techniques of dealing with large systems were published in the seventies. The first meeting on Intelligent Control was in 1985 (at RPI, Albany, NY). The first meeting on Applied Semiotics and its Applications in Architectures for Intelligent Control — in 1995, Monterey, CA.

The fundamental role of signs and other symbolic systems for analysis of intelligent systems, is doubtless. This fact was not very clear at the time of the Dartmouth meeting of 1956. The meetings on self-organization brought this issue to the attention of researchers. The period of the 60's through the 80's can be characterized by a gradual increase of the attention to this issue. Sign systems enter our activities under different disguises: in a form of automata languages, computer languages, systems of indexing related to data and knowledge bases, technological notations for the CAD/CAM systems, and sign systems in Man/Man and Man/Machine communications.

Starting from the road signs and ending with sophisticated terminological systems, our activities and the activities of man-made intelligent systems are permeated with semiotics. It is astonishing to realize that we are actually unprepared to properly handle sign systems and thus, cannot properly discuss the intelligent activities as processes in sign systems. It seems, now is a good time to reconsider the

^aIt is interesting that at the meeting of the Library of Congress on November 8, 1995 in his introductory word before the speech of Umberto Eco, the Librarian of Congress, Dr. James H. Billington said that semiotics is not so widespread in the scholarly life of the United States. It is better known in the Europe, and especially in Russia where the best and the most non-standard researchers usually communicate under the colors of semiotics.

assumptions and definitions related to the area of Intelligent Systems.

2. Intelligent Systems: Can We Distinguish Them from Non-Intelligent Ones?

It is our intention to delineate a synthetic image of an intelligent system. This image should allow for generating a definition equally related to humans, animals, autonomous robots. This definition will focus upon those features that can be considered "features of intelligence", and be perceived by the scientific community with no controversy. Let us consider several answers to the question proposed in the title of this section:

2.1. Researcher answers

This group of answers is trying to implicitly define the intelligent systems based upon numerous "objective" tests:

- (1) Turing test was proposed by A. Turing in 1950.¹⁴ In one of this test scenarios, a human judge interrogates a program through an interface. If the program can fool the human into believing that responses come from another human and not from a computer then the program should be considered intelligent. Clearly, in this test we do not talk about intelligence as a phenomenon but rather about an ability of pretending to be intelligent. At the present time, such an approach seems to be a naive one. Nevertheless, this approach has generated a lot of literature in particular the famous problem of Chinese room.¹⁵
- (2) L. Zadeh's test can be formulated as follows: a paper is presented to the computer, and it is supposed to transform it into an abstract.^b A quality of the abstract can be judged upon by the ability of a computer to extract the meaning of the paper in a sufficiently concise form. No doubt, any system that can do it should be considered intelligent. But what if the computer cannot do it, but it can do other intelligent things? (On the other hand, the problem of

^bIt was proposed by L. Zadeh at SMC IEEE Annual Conference in 1995 in Vancouver, Canada.

meaning extraction is not yet clearly defined; different intelligent people can see different meaning in the same paper, and interpret it in a different way. What can we do with this predicament?)

- (3) Other tests can be formulated which demand different levels of knowledge, skills of reasoning, and degree of sophistication. For example, you can ask a computer to analyze photographs of three-four different artists, then analyze three-four art pieces, and then make a judgment of who was the author of each piece. Interestingly enough, people often give successful answers depending on their reading of the artists' character from the photograph and analyzing art pieces (even if they do not know the actual artists and their works^c). I would not dare to propose this as a test for a computer program, but wouldn't be it a really test for intelligence?
- (4) Various tests can be proposed based upon more mundane but more practical evaluations of sophistication and rationality. For example, we can check a capability of a program to generate alternatives of the decision to be made in a particular situation, and to select one of them properly; or its capabilities to analyze the experimental data related to a particular physical system, and to compute a feedforward control and feedback compensation. The key issue in the last case is the ability to use the experimental data: different experimental data require different approach to computing feedback control, and different laws of feedback compensation.

2.2. *Answers based upon descriptive enumeration of the properties of intelligence*

A list of properties that intelligent system must have was given by A. Newell in Ref. 16:

- (1) It must recognize and make sense of a scene.
- (2) It must understand a sentence.
- (3) It must construct a correct response from the perceived situation.
- (4) It must form a sentence that is both compre-

hensible and carrying a meaning of the selected response.

- (5) It must represent a situation internally.
- (6) It must be able to do tasks that require discovering relevant knowledge.

Another example of a descriptive attempt to define intelligent systems is related to the area of intelligent manufacturing: "*Definition*: The intelligent machine tool is defined by comparison with an intelligent human machinist. A higher level scheduler can rely on both of them in the same way. A given input leads to an expected output. Or, the intelligence reports back that the input is beyond the scope of the current system. We must therefore acknowledge that the degree of intelligence can be gauged by the complexity of the input and/or the difficulty of *ad hoc* in-process problems that get solved during a successful operation. Our unattended, fully matured intelligent machine tool will be able to manufacture accurate aerospace components and 'get a good part right the first time'^{17,p.8}

2.3. *Answers given by pragmatic scientists*

This group aims into getting an opportunity to have formal clues of distinguishing an intelligent system. For example: "If a system uses fuzzy techniques and neural networks then it must be considered intelligent" (obviously, because this is how this group prefers to define intelligence).

It seems undeniable that one can build both intelligent and non-intelligent systems using both fuzzy and neural techniques. Yes, somehow fuzzy and neural systems lead into the domain of intelligence but how?

2.4. *Cognitive and anticognitive answers*

Traditionally, the evolution of intelligence is perceived (quite understandably) as a development of mechanisms of survival associated with building up the models of the World and the tools of understanding the External Reality. The tendency of being introspective should not be considered a *bias* of cognitivists — this is their *method*.

- (1) J. Albus observes an inclusive view of intelligence¹⁸ and he gives several definitions of it, all

^cSimilar test can be found in "Time" magazine, October 16, 1995, p. 107.

of them alluding to the integrative role of this faculty of a system, or a creature related to decision making, knowledge representation, perception, genes propagation and others.^{18,p.474} The invariant kernel of all cases he addressed is “the ability of a system to act appropriately in an uncertain environment, where appropriate action is that which increases the probability of success, and success is the achievement of behavioral sub-goals that support the systems ultimate goal”. He proposes Architecture for Intelligent Systems which we show in a simplified form in Figs. 1 to 5 of this paper. Based upon his concept of this architecture, J. Albus and his team has developed the RCS architecture which allows for intelligent control in a multiplicity of applications. We believe that his definitions and results are fundamental for the development of all facets of the theory of intelligence including those focused upon in this paper. Although he targets engineering applications, his obvious target is also the architecture of cognition in living creatures.

- (2) A. Newell links intelligence with cognition and cognition with knowledge¹⁹: “The system is *intelligent* to the degree that it approximates a knowledge level system ... 1. If a system uses all of the knowledge that it has ..., it must be perfectly intelligent ... 2. If a system does not have some knowledge, failure to use it cannot be a failure of intelligence ... 3. If a system has some knowledge and fails to use it, then there is certainly a failure of some internal ability ... (p. 90)”.

A. Newell and his colleagues has created a conceptual structure and software system for imitating intelligence — SOAR. This system also targets different types of cognition although A. Newell’s group is not very persistent in achieving far reaching parallel with actual cognition mechanisms of living creatures. The issues of integration and knowledge organization are central in his results.^d

- (3) In the meantime, some of the answers are belligerently anticognitive: “One problem with using human intelligence as a basis for AI

is the tendency to confuse intelligence and cognition”.^{20,p.23} The very term “cognition” is being perceived as a claim of anthropomorphism. The same authors are trying to clarify their view by proposing their definition of what intelligent behavior is: “Three basic principles of intelligent behavior are that behavior requires a body, that behavior is intelligent only by virtue of its effect on the environment, and that intelligent behavior requires judgment”.^{20,p.24} The obscurity is not eliminated even after the formal definition is given: “*Intelligence*: In defining intelligent behavior, what matters is the behavioral outcome, not the nature of the mechanism by which the outcome is achieved. In particular, intelligent behavior does not necessarily involve cognition”.^{20,p.282}

- (4) We can see that these authors are inclined to judging upon intelligence of a system in a way similar to the one described in the Turing Test: if you can fool the experimenter — you are intelligent. And how staunchly this contradicts to the statement of A. Newell, one of the most prominent cognitivist of our time: “that a system’s behavior can be predicted based only on the *content* of its representations plus its knowledge of its goals — is the essence of being an intelligent system”.²¹ In this paper we follow the cognitivists general approach.

2.5. *The answer which attempt to avoid the problem*

This is an example of such an answer:

“Intelligence is in the eye of the beholder”, in other words, “if one wants to call something ‘intelligent’ why not?”

The attitude of the answer is a very peaceful and therefore a very tempting one. This is a frequent attempt to eliminate the problem by declaring that the problem is absent. This attitude has generated many terms that can be found in a market place, such as “intelligent screwdriver”, “intelligent vacuum-cleaner”, etc. Certainly, anything, goes into the world of advertisement and customer persuasion. Nevertheless, in this paper we are interested in finding whether such phenomenon as “intelligent systems” really exists and can be properly defined.

^dThe results of SOAR group are collected in the 2-volume set *The Soar Papers: Research on Integrated Intelligence*, edited by P. S. Rosenbloom, J. E. Laird, A. Newell, MIT, Cambridge MA, 1993, p. 1438.

2.6. Unusual answers

Some of them are very promising. For example: “the system can do symbol grounding it is intelligent”. Symbol grounding problem has emerged recently in AI: “The problem of attaching meaning (with respect to the creature) to the symbols it employs is often called the problem of *symbol grounding*”.^{22,p.130} Clearly, the understanding is growing that a meaningful manipulation of knowledge requires defining a totality of intimate relationships between symbolic systems and knowledge bases. Other treatments of the symbol grounding problem suggest its benefit for discovering some of the still obscure parts of the cognitive processes.²³ We believe that mere appearance of this problem testifies for an increasing gravitation of a discourse in the area on intelligence toward the semiotic paradigm. Later in this paper, we will demonstrate that under semiotic approach, the symbol-grounding problem is always in the focus of attention.

One of the most unusual answers dwells upon the fact that anything understood and formalized as an algorithm does not seem “intelligent”, it seems “routine”. This is why a circular definition emerged: “A system is intelligent if it is more intelligent than what can be considered intelligent today”. We expect that this aspect can be helpful in searching for the best definition.

3. Innocent Blunders, Persistent Delusions, and Wild Hopes for Miracles

All of these things are necessary parts of a research process, and they should be rather praised than criticized. However they should be properly tagged in the overall knowledge base of the scientific process because one of the important parts of this process, is teaching. Therefore, once in a while we should reconsider the results of the not so remote past and make an attempt to properly categorize the milestones of this past. The innocent blunders which can be frequently found in the area of intelligent systems, are based upon the provisional *myths*, or provisional *paradigms*. Researchers create these myths, are frequently driven by them, and place within them the contexts of their future theories. We will list here some of them.

- (1) Myth 1. If all subsystems are built of neural networks the system would not have a choice: it will become intelligent sooner or later. Maybe not immediately — after some learning, maybe not with a small number of neural networks — with a large number. But it will become intelligent! Subsequent blunder: equipping a system with neural networks can make this system intelligent.

It is obvious that a neural network is just a tool. Frequently, it is a tool of finding the best approximation of a spatial property, and/or of a temporal process, for which a multiplicity of instantiations is known. Clearly, to make a good approximation is a right thing to do, but it is wrong to think that multiple capabilities for a good approximation makes up for an intelligence.

- (2) Myth 2. An activity of a very complex system which is driven by a hierarchical cognition-like architecture can be substituted by joint functioning of the myriad of the lowest level actuators, each equipped by a local “reactive intelligence”, i.e. by “stimulus-response” rule of action. These “agents” are supposed to be given an opportunity to freely negotiate and discuss their local situations. (The expectation is that when the system relies upon the lowest level of rules “information→action”, the symbol grounding predicament is always adequately resolved.) Subsequent blunder: if all functions of the system are divided among simple intelligent agents equipped with a reactive/reflective rules, and each of them oriented toward a simple elementary problem, thus, generating an elementary behavior — then the overall system becomes intelligent.

So far, the only intelligent property demonstrated for this type of system design was flocking together of little mobile robots which are given a skill of “wandering aimlessly”.

An opinion that *planning* and *reactive behavior* are different categories, is an example of persistent delusions. Within the intelligent system, the World is represented at many scales (or at many resolutions). As soon as we realize that intelligent systems generate behavior at many levels of resolution simultaneously, we come to understand that any reactive

behavior generated at a particular level, is a “plan” for the adjacent level of a higher resolution. Behavior is reactive if it reacts to the events observed in a situation. Thus, plans can be reactive too. It seems that the picture is different if behavior is generated as a result of active anticipation (prediction) of the course of events. Sadly enough, it remains reactive. The only difference between the cases is that we react either to our current observations, or to our anticipations (predictions).

Plans become active, indeed, when we pursue the course of events by actively shaping the very event which is supposed to emerge. Very often we call it “feedforward control” (FFC), while reactive and even anticipatory compensation, we call “feedback control” (FBC).⁶ Using this terminology helps in eliminating some of the persistent delusions such as counterpoising “planning” and “reactive control”. (Some of the AI researchers arrive at the same concept of FFC and FBC in a difficult way by discussing concepts of “situated actions” which presume to include “deliberative” and “reactive” actions as a kind of FFC and FBC incarnations.²⁴

Finally, hopes for miracles are very common: any research is linked with a hope for a miracle. An expectation of a miracle can become harmful if it is a sole motivative factor for the research. One of such expectations of a miracle is linked with a belief that “intelligence” is demonstrated when the solution emerges by itself out of communication among the mass of agents. “Emergence” have been observed for very large collections of non-linear components (re: chaos, etc.). An expectation appears that if many-many units are put together, each of them equipped with, say, a genetic search system — the overall system will be doomed to become intelligent!

One can agree that the model of multiple elements, interacting and genetically searching, is a very inspiring model. What if this model can produce “emergent” phenomena which allow for many powerful scientific results? Well, it seems to be as remote from explaining intelligent systems behavior generation, as prebiotic protein processes are remote from explaining the human brain.

Another hope for miracle that can be frequently found in the literature, is a hope for an intelligent system *without representation*. This idea is motivated by a comparative analysis of so called “western” and “eastern” models of consciousness and

thinking. Allegedly, the first is based upon discretization of the continuum into entities, while the second allows for “fluid”, meditative processes which seem to be conducive of creativity. We will address this issue in more detail later in our discussion on continuum and its discretization.

4. Generalized Subsistence Machine: A Unity of Body and Mind

Generalized Subsistence Machine (GSM) is defined as a system which is unified by a goal *to exist as an entity*. In pursuit of this goal, GSM can perform tasks which has been developed internally, or submitted externally. The phenomenon of being *unified by the goal to exist* is fundamental in the subsequent discussion of GSM and its operation. As a system, GSM can contain a set of subsystems which can be regarded as GSM, too. Let us formulate these statements as postulates.

- *Postulate (1) of Unity:* The fundamental goal of GSM is to exist as an entity without compromising its integrity even though it can be part of another GSM.
- *Postulate (2) of Recursion:* Any GSM can be considered a part of another GSM (in which the GSM under consideration is nested), and can be considered as a composition of other GSMs (which are nested in GSM under consideration).
- *Postulate (3) of Existential Duality:*⁶ Each GSM is presumed to consist of two parts (GSMs too) which are vitally required for its existence: the first takes care of goal directed functioning while the second takes care of the subsistence (including maintenance) of the first one; they are denoted GSM^G and GSM^S correspondingly.

Corollary. Any GSM^G should be considered together with a hierarchy of goals to be pursued in external environment; the GSM^S is thought of as a part of the environment in which GSM^G is functioning. At the same time, any GSM^S should be considered together with a hierarchy of goals of maintenance to be performed internally; the GSM^G

⁶It should be introduced as a “postulate of existential plurality”. However, since throughout the entire paper only the case with two parts of GSM is discussed, the duality was left in the formula of the postulate.

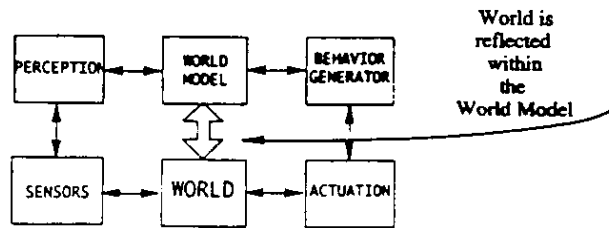

Fig. 1. Generalized subsistence machine.

is a part of environment for GSM^S . Both GSM^G and GSM^S form their nested systems.

We would argue that for analysis of the totality of GSM functioning, the closed loop model should be considered as shown in Fig. 1. This Six-Box Diagram can be discovered within each GSM and its components are interpreted according to the problem to be solved. Following the initial postulates, each of the boxes of the Six-Box Diagram can be considered as GSM, too. This means that its boxes can be decomposed in their subsystems and are subsystem itself nested within other GSMs. For each of the boxes, hierarchies of GSM^G and GSM^S can be formulated too.

4.1. Sensors

This is any device or technique which performs a goal of receiving information and transforming it into the encoded form which allows for further processing. For an air conditioner, it is a temperature sensor. For a coordinate table, it is an optical encoder installed on the shaft of the electrical motor. For a robotic cell, it is a multiplicity of measuring devices which testify for a status of each machine in the cell.

4.2. Perception (sensory processing)

This subsystem has a goal to receive the encoded information from sensors, to organize it by initial grouping (clustering), to tabulate it, to tag, and to index it, and then to interpret it by extracting and encoding the entities which can be found within the flow of this encoder information. In a case of computer vision sensory processing performs pixels registration, edge extraction, segmentation, discovering groups of segments, and recognizing meaningful known and unknown objects. All these opera-

tions should be performed in such a way that the whole scene could be submitted to the World Model. Recognition and subsequent interpretation of the scene (situation) requires dealing with vocabularies within which the components of interpretation are initially found. Obviously, this process of scene interpretation demands for some communication with the World Model which contains the contexts guiding the process of interpretation. This communication can include all kinds of issues with value judgment and ending with suggesting the subsets of vocabularies to be used during the process of interpretation.

4.3. World model

World Model (WM) contains all information about the world belonging to different spatial and temporal scales. WM allocates the results of scene interpretation as a part of the present situation, and discovers changes that should be attended and probably responded to. The present situation with the relevant changes indicated, and conflicts discovered are submitted to the Behavior Generator (BG). WM communicates with BG because the latter is aware about the goals, and therefore helps in focusing attention upon particular subsets of WM.

WM can be equipped by a subsystem of learning which stores experiences in the form of cause-effect chains, then generalizes upon them, conjectures new rules of action as hypotheses, then collects the results of applying these conjectures. WM extracts "concepts" from the rules that have received multiple confirmation, and interweaves them into a corresponding relational network of concepts. In order to learn, WM should be able to distinguish "good" experiences from "bad" ones. Thus, WM has also a subsystem of Value Judgment. Sometimes this subsystem is demonstrated as a separate subsystem of GSM (see Fig. 10).

In some of the existing descriptions of the Six-Box Diagram, the World Model is interchangeably used with the term "Knowledge". We prefer to use the term "World Model" to emphasize the fact that the process of knowledge organization is equivalent to the process of modeling. It cannot be done without considering the whole loop of Fig. 1, and the system's goals in the reality of the World. Thus, we prefer to use *World Model* instead of *World Representation*.

4.4. Behavior generation

The goals are either formed as a result of communication between WM and BG, or are submitted externally. BG analyzes the state-space in which the present situation and the goal are described and searches for the alternatives of spatio-temporal development of the process that leads to the goal. Selection of the best alternative requires an ability to make a value judgment. The alternative chosen is regarded as "feedforward control" or "plan". It is decomposed, and its components become tasks for the GSM components. As soon as the execution of plans starts, BG analyzes the deviations observed and computes commands for compensation. Simultaneously, it submits information to BG about the need to introduce corrections to particular models. Since the goal suggests the cost, one of the alternatives can be chosen and submitted to the actuators.

4.5. Actuators

Actuators transform the encoded desirable course of actions generated in BG, into real actions (motion). Actuators can be considered animal muscles, electrical motors, physical plants, army regiments, etc. From these examples, it is easy to deduce that actuators often contain many GSMs that allow for further decomposition. Actuators create changes in the World.

4.6. World

This is the Reality in which everything happens, in which actuators create changes, external factors act independently, and sensors receive some information about this. The arrow between the world and the world model shows that some resemblance exists between Reality and WM. The World is reflected within the World Model, but reflected incompletely, inadequately and often erroneously. Six-Box Diagram can be considered a result of immersion of an autonomous agent (with a set of inputs and a set of outputs) into a special environment (World), as shown in Fig. 2. However, it is convenient to organize information in a form presented in Fig. 1, advantages of this become obvious when the multiresolutional representation evolves.⁶

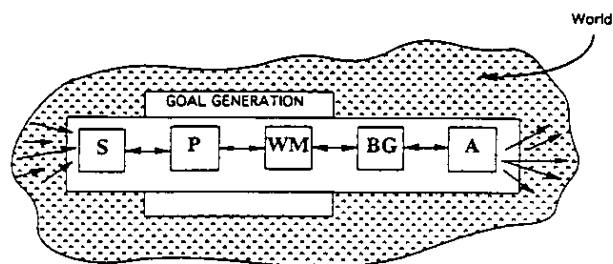

Fig. 2. GSM viewed as an intelligent agent.

Analysis of GSM functioning for each problem at hand, should be done only in a form of an analysis of the complete loop shown in Fig. 1. This is not always followed in practice. Indeed, sometimes a research group can receive an assignment: select sensors for the particular machine. It is presumed that the loop is implicitly given because the input and output specifications for the Sensors are formulated prior to the beginning of this work. However, the process of selection cannot be bound by the mere satisfying of two lists of specifications; it requires considering the whole loop of Fig. 1 at all stages of discussion. In other words, no matter which box is discussed, GSM should be analyzed in all its entirety. Certainly, no discussion of the system's intelligence can be productive unless of full GSM is considered as a whole. (Notice, that running GSM as a closed loop automatically takes care of the symbol grounding problem).

In the discussion of the Six-Box Diagram, we did not emphasize the inner structures of the boxes, their algorithmic and operational mechanisms. These mechanisms are similar in all boxes, and employ an elementary unit of intelligence which can be applied to the multiplicity of problems being resolved in GSM. However, languages of communication mapping the information among the pairs $W \leftrightarrow S$, $S \leftrightarrow SP$, $SP \leftrightarrow WM$, $WM \leftrightarrow BG$, $BG \leftrightarrow A$, and $A \leftrightarrow W$, are different.

Six-Box Diagram represents all activities of the system as a bulk. It can be applied both for GSM^G and GSM^S. Let us discuss the joint functioning of GSM^G and GSM^S within a GSM. The automata-like diagram in Fig. 3 shows that any autonomous GSM has two groups of functioning: Goal Directed Functioning (GDF), and Regular Subsistence Functioning (RSF).

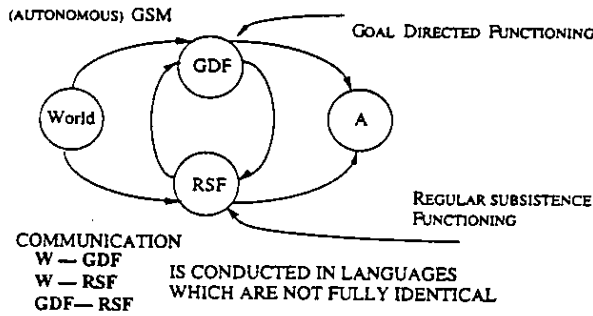

Fig. 3. Decomposing the intelligent agent into two parts: one for a goal directed and another for a regular subsistence functioning.

GDF corresponds to the main function of a system, say, the process of energy generation of the power plant, while RSF corresponds to the maintenance system of this plant. Thus, we consider three types of communication: $W - GDF$, $W - RSF$, and $GDF - RSF$. This communication is conducted in languages which do not allow for fully adequate interpretation of messages. Therefore, when GDF and RSF communicate with actuators A, the results of behavior generation often differ from the desired ones.

A question can be raised: How large the vocabularies of languages for automata representation should be? Their size obviously affects the size of transition and output functions of this sequential machine. The answer is embedded in the very nature of GSM, as shown in Fig. 1 — to find languages the prior experiences should be analyzed. GSM is a learning machine,^f and learning is a process of constantly generating new rules and concepts using experiences.

Thus, the automation in Fig. 3 is not a standard automaton with finite vocabularies. It has open list vocabularies, transient, and output functions, and all of these components of the automaton grow constantly. The way how it is done, is determined by the architecture of intelligence. Learning processes are implied by the nature of the kernel operation of intelligence which will be presented later. At this state

^fNotice, that the term learning is not defined yet; it can include a multiplicity of activities starting with memorization and updating and ending with proposing theories for generalization of prior observations.

we declare that learning is not recording of all processes which have taken place; it is not just memorization of experiences; rather it is the development of the World Model by using generalization of experiences.

5. Emergence of the Multiscale GSM

So, we do not know yet how does an intelligent system work, but we know that it provides for successful functioning of GSM (Generalized Subsistence Machine) in the reality of the World. We also know that GDF (Goal Directed Functioning) and RSF (Regular Subsistence Functioning) of GSM should be able to transform the symbolic description of the World situation into symbolic description of actions under a particular goal (which is a description of behavior to be generated). This transformation is what is called a Behavior Generation (BG).

Extracting entities from the Reality is a prerequisite for this transformation because the vocabularies are formed for the World and the Action descriptions. Since the description of actions can be done through incremental changes in the World description we come to a conclusion that building the vocabulary of the World is a prerequisite for behavior generation. Each vocabulary is a list of words which are symbols for encoding entities of the World. *Entity* is defined as a thing that has definite, individual existence in reality or in the mind; anything real in itself. In other words, entity of the World is anything that exists, has a meaning and is (or should be) assigned a separate word. Therefore, functioning of intelligent systems requires understanding of how entities can be discovered within the World.

The Reality is presumed to contain: (a) entities that we have already learned; and (b) the rest of the Reality that we have not yet learned and therefore cannot list its entities. It would be prudent to regard anything unlearned to be a continuum, and a process of learning to be a process of discovering entities within this continuum. (Continuum is defined as a thing whose parts cannot be separated or separately discerned).

From natural sciences we know that physical laws work in such a way that singular entities are formed from the initially uniform media, and thus, separated from the continuum. We mentioned that these entities are assigned symbols, and they become words

in vocabularies. The status of being a word in a vocabulary invokes the need in some meaning to be assigned to this word: remember, that these words are parts of the GDF and RSF automata, and are expected to be recognized by their transitional and output functions. The separation of entities from the continuum is a result of thermodynamic processes and mechanical motion. Indeed, the cosmogonic theories of emergence of planets and stars from the chaos of previously disorganized matter illustrate entities generation from the chaos. One can see that for natural systems the automata GDF and RSF are the explanatory theories introduced within a particular science. For additional examples, see sources on processes in non-linear systems and catastrophe theory.^{25,26}

In other words, natural processes in physical world lead to the transformation of the primordial chaos (actually, continuum) into a collection of relatively "thick" zones where the particles of matter stick together (they become entities), and the less thick zones with relative uniformity (they are remainders of the continuum). It is necessary to remind again that, as entities, they have a status of words, they are parts of the automata GDF and RSF, and they have a meaning assigned to them. Notice, that the concept of scale was not mentioned in the previous description although this concept appears implicitly. Indeed, the "particles" that have been mentioned, are probably results of entity separation from the continuum on a substantially finer scale. We have not mentioned "scale" yet, because the concept of scale presumes an observer, while the processes, we describe, develop in nature no matter whether an observer exists or not.[§]

This physical decomposition of the chaotic world into different kinds of uniform media, and a variety of singular entities, can be thought of as a natural classification that happens in the world independently of the observer (see the first top-down forking of the Reality in Fig. 4). Formation of singularities (as entities) can be metaphorically described as a result of gravitation of elementary units of the

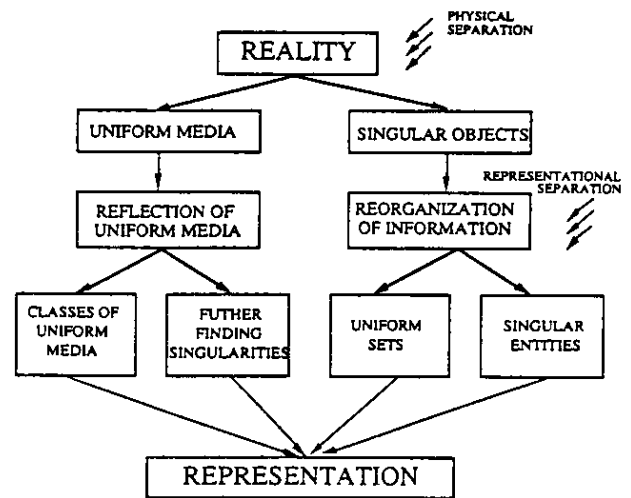

Fig. 4. Stages of entity formation in the Reality.

chaos to each other in the areas of continuum with a higher density of these elementary units. For clarifying this metaphor, we should emphasize that for the further discussion it is irrelevant whether the density is increased as a result of a gravitation, or gravitation starts prevailing because of an initial increase in density.

Let us consider these processes in computational terms. At this point the observer will legitimately appear in our presentation as a carrier of two inter-related concepts: scale and resolution. (Resolution is determined by the size of the smallest distinguishable zone, a pixel, or a voxel of the space in which we describe our system.^h Scale is a value inverse to the resolution.)

The concept of scale allows for introduction of a formidable research tool which can be applied for each couple of adjacent levels of resolution. This tool is related to the specifics of a different interpretation of units in a higher and lower levels of resolution (HLR and LLR). The units of the HLR emerge as a result of singularity forming process at the previous, even higher resolution level (which is not a part of our couple levels of resolution under consideration). After

[§]At the present time there are software packages which allow for simulating the processes of entity formation, see for example, K. Yip, F. Zhao, "Spatial Aggregation: Theory and Application to Quantitative Physics", *Proc. of Symp. on Abstraction, Reformulation, and Approximation*, Ville d'Estérel, Quebec, Canada, August 1995.

^hWe always presume that some System is to be analyzed and/or controlled. This also determines that there is some external context, and all meanings and interpretations should be consistent with this context.

these singularities have been formed, they receive an interpretation, a meaning, a separate word of a vocabulary at this HLR. For the LLR of the pair of levels that we discuss, these particular singularities have no meaning at all — not yet! The meaning will emerge after these entities of HLR will assemble together into a singularity which can be recognized at this LLR as a meaningful entity. Before grouping of these entities into meaningful singularities happened, they are just nameless units with a tendency to gravitate to each other, expressed in the set of their relations. So, the process of entity formation for LLR recognizes the entities of a HLR just as a set of anonymous units. Their gravitational field is to be investigated which can give a birth to a new entity of LLR.

Uniform medium is always a collection of some non-uniform units at a finer scale (at higher resolution), and uniformity of the medium is a parameter which we obtain from characterizing the medium at a coarser scale (at lower resolution). In order to compute this parameter (the degree of uniformity, or density) different techniques can be used. All of them work as follows. Let us consider a particular zone of the medium which we intend to evaluate; we will call it *the scope of interest*. An imaginary window (*the scope of attention*) is to be imposed upon the medium (*scope of interest*). Notice, that the size of the scope of attention is presumed to be substantially smaller than the scope of interests. Density of non-uniform units is to be computed within this window which allows to evaluate the continuum quantitatively. Then the window is sliding over the whole scope of interest, and in each position the density is again computed.

The window sliding strategy is assigned in such a way that all scope of interest be investigated efficiently. This strategy can be different in different GSM: we can scan it in parallel manner, we can provide a spiral trajectory of scanning, we can make random sampling from different zones of the scope of interest, the strategy selection should depend on needs, hardware tools, and resources available (for example, time). If values of density are about the same everywhere (with small variations within some particular interval) then the medium is considered to be uniform. Notice (a) that in order to introduce the concept of uniformity we used a sliding window which is one of the techniques of *focusing attention*;

(b) that in order to form entities of a particular level of resolution we should *group* the units declared entities at the higher level of resolution; (c) that to find candidate units for grouping we should *search* for future members of these groups or otherwise *combine* them together. Later we will return to these operations as components of the elementary unit of intelligence.

The subsequent classification is performed within a system by an observer (presumably, GSM). The observer perceives a multiplicity of zones of Uniform Media (UM) with various degrees of uniformity, and groups them in different classes. The sets of classes of uniformity can be thought of as singularities by themselves, thus, singular classes of uniformity in addition to singular entities are determined as a result of perception. Then the whole host of singular objects reflected by GSM is informationally reorganized, and new sets of objects are formed pertaining to different levels of resolution. At each level of resolution there are additional singular objects: those, left out from the previous grouping processes. These “left-out” entities supplement the multiresolutional system of entities that has been received. After this, a new iteration of grouping is supposed to be performed at each level of resolution.

As a result of this computational process, a multiresolutional system of world representation is obtained as a nested hierarchy of symbols (words). While this vertical (top-down/bottom-up) process progresses of finding entities and classes of media in which these entities are immersed, the horizontal processes develop of verifying the meaning of the entities and the media.

The goal of a horizontal computational process is to explore how new sensory information has been transformed into the output of perception, how the latter fits within WM at each level of resolution, and how meaningful actions can be implied by the world model at this level and the goal produced by the adjacent level above. Each of these horizontal processes runs in the GSM structure, which is supposed to be formed at each level of resolution. Without this process of verification by running all levels through the multiresolutional system of GSM (Fig. 5) the world representation could not be viewed as consistent.

As soon as the multiresolutional GSM is actually formed by this strategy of computation, it becomes clear that vertical consistency within the

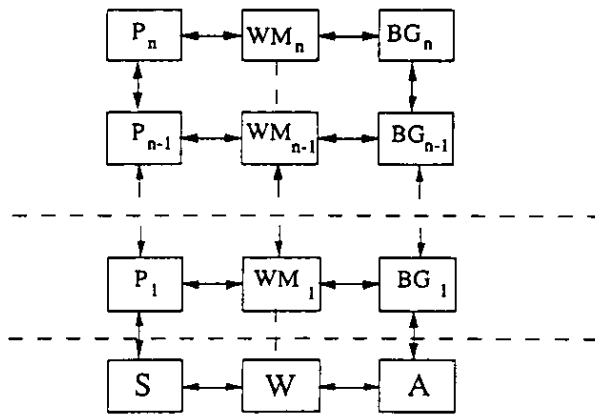

Fig. 5. Multiresolutional GSM.

multiresolutional system of World Model (WM) is not sufficient enough. Two additional consistency checks are required: one of them top-down/bottom up consistency check within perceptual system, and another top-down/bottom-up consistency check within the system of Behavior Generators (BG). The latter produces a system of goal decomposition which is critically important for GSM functioning.

Multiresolutional hierarchy allows for minimizing the complexity of information processing by selecting the optimum number of resolution levels.²⁸ For different systems it gives different number of levels. Thus, a problem can emerge of communication between two or more hierarchies belonging to the same level of resolution, and yet having different number of levels. In Fig. 6, we illustrate this phenomenon by demonstrating hierarchies of GDF and RSF which both are required for functioning of the same system. However they are different in their goals, realizations, and their number of levels. Levels belonging to different hierarchies must communicate whenever their vocabularies allow for this (see Fig. 6). At the present time the problem hardly can be addressed theoretically (although a theoretical analysis can be expected in the future).

- *Postulate (4) of Communication.* Intelligent Systems which are supposed to coexist as parts of other intelligent system, but which have different number of resolution levels, should communicate whenever and wherever the resolution and interpretation of the words in the vocabularies of the resolution levels allow for the communication.

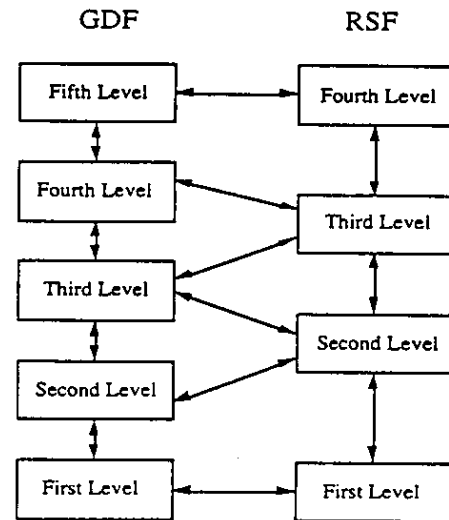

Fig. 6. Interaction between the multiresolutional hierarchies of GDF and RSF.

The “technology” of dealing with continuum was practically known and theoretically anticipated by mathematicians. We will mention here only a testimony by E. Schrödinger who eloquently describes the tradeoffs which always emerge when the scale, accuracy and/or chunking of continuous information are involved. Analyzing the process of dealing with a curve containing pieces of functions of the second order, he writes:

“We claim to have full knowledge of every point of such a curve, or rather, *given* the horizontal distance (abscissa) we are able to indicate the height (ordinate) *with any required precision*. But behold the words ‘given’ and ‘with any required precision’. The first means ‘we can give the answer when it comes to it’ — we cannot possibly have all the answers in store for you in advance. The second means ‘even so, we cannot as a rule give you an absolutely precise answer’.”²⁷

In order to proceed with these processes of forming and classifying singularities¹ and the

¹The multiresolutional system of entities obtained as a result of the procedures described in this section should not be confused with “abstraction hierarchy”. This is rather a hierarchy of generalization (which does not coincide with hierarchy of aggregation either). We suggest to be cautious with these three terms: abstraction (ant. concretizing, concretization), generalization (ant. specialization), and aggregation (ant. decomposition). They (and their antonyms) are easily confused.



Fig. 7. The pattern of drainage in the saline mud (Lake Natron, Tanzania).^j

media surrounding them, the following operations are required which are applicable, both to the physical objects and their symbolic representations: (a) grouping of the units (physical and informational); (b) selection of subsets of these units (subsets which are “preferable” in some sense); (c) searching among the units, sets, and subsets to support subsequent processes of clustering, and otherwise constructing the combinations.

6. Elementary Procedural Unit of Intelligence

6.1. *On the resemblance among processes of structuring in nature and representation*

It is clear that an introduction of all of these techniques: focusing attention, grouping and combinatorial search is motivated by substantial simplification in the symbolic system which leads to the reduction of computational complexity. Indeed, at a particular level of resolution we need for the whole

medium just one symbol. For each singularity — one symbol. For a class of singularities having one attribute, also one symbol. It has been demonstrated that by using focusing attention and combinatorial search while grouping solutions under minimum cost requirements in the system with three levels of resolution, the amount of computations can be reduced from 10^{17} to 10^3 .²⁸

A question can be raised: “Yes, in the system of representation of GSM, the substitution of the continue by the multiresolutional system of entities is meaningful because of computational complexity reduction. Why should it be meaningful in the domain of Reality? Why Nature needs to form entities which would be understandable as if it is a system of representation?”

The answer is, that strangely enough, the laws of processing for physical matter and energy are similar to the laws of information processing because both can be represented symbolically (otherwise to understanding would be possible) and because both have cost functionals that should be minimized. Indeed, why should a heated oil in a plate be tessellate (spatially discretize) itself in a multiplicity of hexagonal cells? Because it reduces the amount of energy which otherwise would be necessary to dissipate through

^jG. Gerster, *Below From Above*, Abbeville Press, 1986, plate 117.

the limited overall surface.²⁹ Why does the drainage pattern remind a dendrite and does form not a continuum? (Fig. 7) Because channeling the drain in a form of branching structure requires less energy to overcome the resistance of medium taking into account all micro and macro hydrodynamics phenomena. Structuring of the continuum helps to reduce the cost in both cases.

Thus, we should not be surprised that in the long way from the continuum of Reality to the structure of Representation there is a good match between natural and informational processes which are plugged into each other (Fig. 4).

6.2. *On the resemblance among the algorithms applied for structuring*

In Fig. 8 the properties of the algorithms for focusing attention, grouping and combinatorial search are described.

One can see that these properties can be provided by a vast multiplicity of different computational schemes. In this paper, therefore, we do not discuss any particular computational scheme. However, it would be proper to mention that forming a multiresolutional system under premises of focusing attention, grouping and combinatorial search is a primary technique in the following wide spread analytical methodologies:

- recursive estimation;
- wavelet decomposition;
- fractal theory;
- any series including Taylor, Fourier, Tchebyshev polynomials and others;
- Lyapunov stability (presumes fuzzification);
- multilayer neural networks (presumes fuzzification);
- multiresolutional variable structure systems;
- multiresolutional dynamic programming.

However, even if complexity reduction of multiresolutional system is not pursued, still GFACS is applied for problem solving in its complete set, or partially. It seems that GFACS reflects the motivation of problem solving for many practical cases. Most of the software packages for computer vision employ GFACS at all stages of image processing.

Numerous algorithms are known in practice which use Focusing Attention (FA), Grouping (G), and Combinatorial Search (CS). FA-algorithms can be driven by a variety of factors: aimless curiosity, communicated or synthesized goals, a recognized danger, and/or observed unusual phenomena. Some values should be assigned to these algorithms if we want them to operate: values of importance for different entities, limits of scope, and values of resolution. G-algorithms are driven by similarity and compatibility (which often should be assigned as external control parameters). They initiate new investigation of the World if the process of clustering failed. Finally, CS-algorithms are equipped with mechanisms of new entities generation (in a form of novel clusters, alternatives of assemblies, alternatives of strings, crossover^k). The existing and newly created alternatives are browsed by CS-algorithms. All of them are evaluated, and then a limited number of them is selected for the further computations).

Some of the working algorithms and the diversity of combinations provided for their features and properties is a special topic and it will be addressed in a special paper.

We will attempt to propose a generalized computational scheme which can generate algorithms applicable for using in multiresolutional GSM. In the previous section we have descriptively introduced a

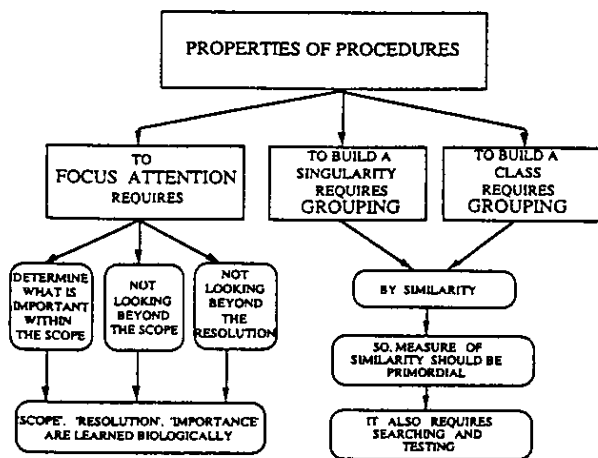

Fig. 8. Properties of the procedures components of the algorithm of generalization.

^kLike in algorithms of genetic search which are also a part of the group of CS-algorithms.

generalized algorithm of information processing which can be presented in the following form:

Recursive Algorithm of Constructing the Multi-scale Knowledge Representation

- Step 1. Get information at the highest available level of resolution; consider the totality of this information a REPRESENTATION AT THE RESOLUTION LEVEL registered as the highest available level of resolution.
- [the processing starts bottom-up]
 - [the smallest units of information are presumed which cannot be further decomposed because the smaller units than this, are indistinguishable; they are regarded as elementary units of the highest level of resolution]
 - [a particular scope (breadth, scope of interest) is considered together with a particular value of the smallest unit of information of this scope (value of resolution)]
- Step 1.1. Investigate the properties of uniformity for the REPRESENTATION AT THE RESOLUTION LEVEL.
- [this investigation includes testing of the information by a set of sliding windows to determine zones of uniformity (constant density) and zones of increased density; the latter are candidates for emergence of clusters because the elementary units seem to gravitate to each other in these zones]
 - [determining density presumes *a priori* existence of the cost function linked with the vitally important properties of space (distance) and units (which might have such attributes as mass, brightness, etc.)]
- Step 1.2. Cluster these units within the zones of the overall scope where they gravitate to each other and label the units received as a result of clustering.
- [These new units can hypothetically be considered elementary units of the adjacent lower level of resolution]

- [The conjecture of mutual gravitation presumes introduction of the cost function which might be richer than the cost function used for investigation of uniformity of the space]

- Step 1.3. Explore the GSM-loop (Six-Box Diagram); if the new cluster does not have any meaning in the GSM-loop, mark it for further exploration at the lower level of resolution with no label assigned at this particular level of resolution.
- [“Having a meaning” means having an evidence of a consistency of the description of GSM functioning as far as the goals of GSM are concerned; later the correspondence to the analysis of “pragmatics” is shown]
 - [At this level “information” is being transformed into “knowledge”]
- Step 1.4. Register the results as REPRESENTATION OF THE LOWER RESOLUTION LEVEL.
- Step 1.5. If no new clusters have been created at this stage then go to Step 2. Otherwise loop to Step 1.1 and explore an adjacent lower level of resolution.
- Step 2. Send all REPRESENTATIONS of the particular resolution levels to the overall system of representation.

This algorithm can be rewritten as follows:

- Step 1. Get information at the highest available level of resolution; consider it a REPRESENTATION AT THE RESOLUTION LEVEL registered for the highest available level of resolution.
- Step 1.1. Investigate properties of uniformity for REPRESENTATION AT THE RESOLUTION LEVEL.
- FOCUS ATTENTION upon all subsets of the initial information set (windowing),
 - GROUP information within the FOCUS OF ATTENTION and evaluate groups.
- Step 1.2. GROUP elementary units within the overall scope; consider the groups (clusters) to be elementary units and label them.

- Step 1.3. Check consistency of the clusters with GSM-loop (Six-Box Diagram); mark the inconsistent clusters for further exploration at the lower level of resolution.
- Step 1.4. Register the results as REPRESENTATION OF THE LOWER RESOLUTION LEVEL
- Step 1.5. If no new clusters have been created at this stage then go to Step 2. Otherwise loop to the Step 1.
- Step 2. Send REPRESENTATIONS of all resolution levels to the overall system of representation.

This algorithm is applicable to a broad variety of processes which determine functioning of intelligent systems.

7. Behavior Generation: Temporal Processes in Intelligent Systems

The main premise of our treatment of the temporal processes development in intelligent systems is the concept of multiresolutional structure. Unlike other (non-intelligent systems) the intelligent ones perform generalization on a regular basis, and therefore has more than one level of resolution at any particular moment of time. This means that temporal development of processes in intelligent systems can be meaningfully discussed if and only if more than one level of resolution is under consideration. The results are different from those discussed at one level of resolution only.

The term *behavior generation* is understood in a broad sense. For example, BG is a course of actions which should be selected and executed in an organized fashion for a manufacturing plant which has to manufacture a new car, when proper sub-goals should be proposed and control activities required should be found which eventually lead to the final goal desired. Another example: BG is also a course of actions which should be selected and executed in an organized fashion when an interpretation of a text, or a series of experimental results is supposed to be found, and the new meanings should be discovered (within a particular paradigm). The inventiveness of BG-subsystem in the first example can overturn the initial goal by proposing a new method of transportation (not a car). For the sec-

ond example too, as a result of BG for interpreting text and experimental results, the need in a new paradigm can become clear. But one thing is important: BG is understood as activities which lead to interpretation and discovery of a real (maybe, a new) meaning.

This development of the BG temporal process at all levels of resolution, as well as its simulation within WM prior to decision making and execution, i.e. *imagination*, is necessary because the system of goals which are pursued by all levels of resolution is an interrelated nested system. This system forms a hierarchy (a fuzzy hierarchy) in which the conditions of nesting should provide the consistency at each moment of time. In other words, everything can go well, each level can perform an excellent job in SP, WM, and BG; the results of SP can be consistent top-down and bottom-up in the hierarchy of levels; WM of all levels can satisfy a condition of consistency too. However, if the goals do not form a consistent nested hierarchy the system cannot be considered an intelligent system proper.

Let us consider a couple of examples. Imagine a system of manufacturing in which all workers are busy and productively machining the work pieces. Their schedules are optimal and the cost of what they do is minimum. However, at the level of the plant (this is a lower level of resolution) the goal is to manufacture an object to which the work pieces that the workers produce do not fit. Clearly, the levels of this systems work under goals that are not consistent.

Another example is concerned with two levels of resolution in a human society: a level of a group, and a level of an individual who is a part of the group. Say, this individual is an extremely intelligent person, his GFACS mechanisms produce excellent solutions that satisfy his intimate personal goals. However, these goals contradict the goal of the group. Therefore, although this particular human being is intelligent and the group is intelligent too, the system would not work as an intelligent one because the condition of goals consistency is not satisfied. It is easy to produce more sophisticated scenarios but it is clear that goals consistency is a prerequisite for functioning.

Structures of behavior generation are described in Refs. 30 and 31. In most of known cases, they boil down to the following scheme:

- (1) Determine (or get from the list of goals) a desirable goal.
- (2) Find a cost-effective process (the string of states, the trajectory) leading to this goal → simulate this process and search for the solution.
- (3) Find a cost-effective string of actions which allows to follow this trajectory → simulate this process and search for the solution.
- (4) Execute the trajectory.
 - submit the commands to the lower levels
 - observe the results and watch for deviations
 - compensate for deviations.

This scheme can be realized via different algorithms. Most of them lead to placing at the level a **PLANNER** which is a device for finding the feed-forward control, and **EXECUTOR** which contains a feedback compensation controller (see Refs. 30 and 31).

8. The Degrees of Intelligence

From the previous sections we can conclude that data bases, or knowledge bases equipped with GFACS become World Models. Sensory Processing systems explicitly and consciously equipped with GFACS become systems of Perception. Finally, a multiresolutional Planning/Control system equipped with GFACS become a system of Behavior Generation. Let us discuss the properties of GFACS in more detail.

8.1. The elementary unit of intelligence

Undoubtedly, the development of different forms of intelligence is (and always has been) enabled by the properties of GFACS package that we have described. Let us illustrate this package as a triangle in which vertices can communicate to each other while processing the information (Fig. 9(a)). The consecutive application of the procedures in vertices provides for all processes characteristic of intelligent systems. The spiral in Fig. 9(b) demonstrates development of the multiresolutional system of World Model. While this spiral works in each box of GSM, the loops of GSM should watchfully explore whether the results of generalization produced by GFACS including the new entities generation, do not violate consistencies within the GSM loops at each level, and vertically throughout subsystems of P (SP), WM, and BG.

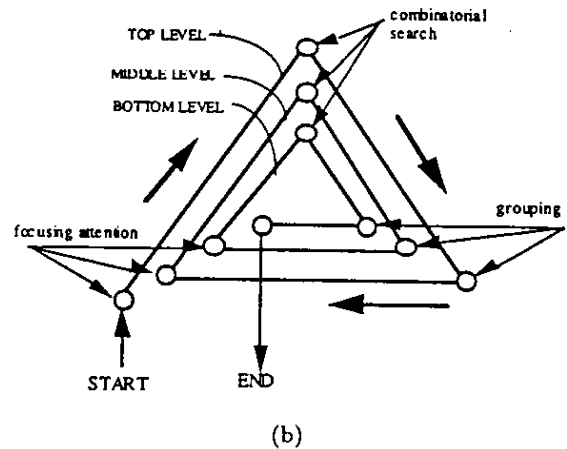
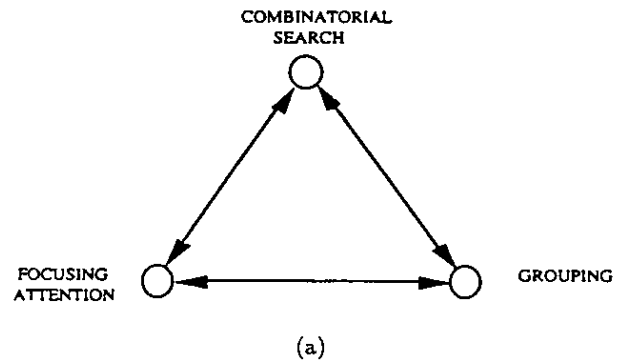

Fig. 9. Elementary Module of Intelligence (GFACS). (a) at a level, (b) computing a multiresolutional system.

Let us apply our scheme to different processes of intelligence.

The development of human intelligence would be impossible without focusing attention by bounding the window of attention at the top and at the bottom. Indeed, our scope of interest in visual perception is bound by our field of view, our scope in hearing is bound by the audio-frequency interval, etc. At the bottom, the resolution is also constrained, and it is good because if we are able to discern all the molecules and atoms in everything that surrounds us, we would drastically overburden our mechanisms of intelligence. In addition to the windowing in the "perception" box of the Six-Box Diagram, we have additional mechanism of windowing at the lower levels of resolution. Indeed, our communication with other people would be impossible if we could not focus our attention selectively only on the person we are speaking right now! Our problem solving process

would be unthinkable unless we are able to concentrate only upon one particular problem we decided to be involved with.

Certainly, our understanding of processes in human intelligence is incomplete, and we often catch ourselves upon the fact that being involved with one problem consciously, we are solving also another problem and suddenly come up with solution, seemingly as a result of some parallel or time sharing subconscious activities. Nevertheless, the power and need for focusing attention is undeniable. It also leads to mistakes when we cut off zones of the state-space which are not supposed to be sacrificed! Well, this is why the reliability of success in our thinking machine is less than 100%.

Focusing attention frequently works as a prerequisite for *grouping*. Indeed, in order to form a group (to cluster, to build a class) and then to label it (to attach a symbol, a term, a word) thus creating a concept, we have to cut off many high resolution entities which we decided not to include in the cluster. We use evaluation of "similarity" and have a threshold value: anything beneath this particular value of similarity does not belong to the group. For evaluating the similarity, we use "measuring" of the potential attributes (properties of the future, hypothetical entity that we create as a result of concept formation).

In some cases, the results of *grouping* are obtained first and then subjected to curtailing, which is also *focusing attention*. This happens when grouping is simple, and it is easy to produce many candidates so that the best could be eventually selected. It does not matter in which sequence these processes are executed (grouping, then focusing attention, or vice versa), the bottom line is forming cohesive groups.

When we cluster based upon the value of similarity and thus, upon gravitation toward the future cluster, we use the "ontology" of the state-space: "this is what happened to be around us". If we are not satisfied with ontology of the world, then we start *searching* for possible components of the future concept that are not around. Moreover, we might be interested in intentional creation of alternatives among which the further searching is performed. This search among combinations intentionally created, we will call *combinatorial search*. The latter is utilized in algorithms of automated discovery³² in systems of planning^{e.g.33} and in system for genetic search.³⁴

No matter what the package you have acquired for your intelligent system is, no matter which company you have bought it from this package, if it is complete, will perform focusing attention, grouping and combinatorial search. If the package is good, it performs GFACS at several levels of resolution, and if it is complete it provides, or requires for the consistency checks: along the GSM loop at each resolution level and vertically across the P, WM, and BG subsystems.

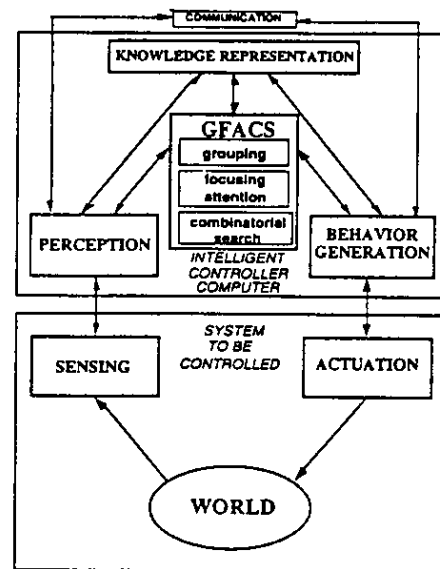

(a)

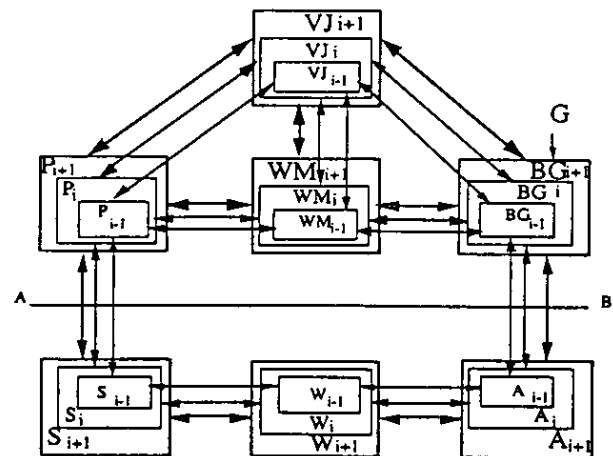

(b)

Fig. 10. GSM with GFACS. (a) GFACS serves to all subsystems at a level, (b) this produces a system of nested GSM.

Table 1. Parameters of GFACS varied by the GSM assignment.

COMPONENTS OF GFACS		
Focusing Attention	Grouping	Combinatorial Search
• degree of importance of entities	• resemblance	• goodness
• value of resolution	• compatibility	• heuristic for alternatives formation
• volume of scope	• closeness	• number of alternatives
	• cohesiveness	

In Fig. 10, the GSM is presented in which GFACS provides for functioning of P, WM, and BG. As a result, the system of nested GSM loops is produced (for more details see Ref. 7).

It is important to remember that GFACS components have parameters to be assigned based upon experience of functioning as shown in Table 1.

8.2. Evolution of intelligence

Stage a (Selecting the Rule from a Set). The simplest knowledge base contains a “stimulus-response” rule in a form of a schema: if a goal G is given in a situation S_1 apply the action A in order to get in a situation S_2 (i.e.: $[S_1 \rightarrow A \rightarrow S_2]^{\text{under } G}$). Here S is a sensed “stimulus” which corresponds to a particular situation, and A is the required response — action. As a sensor delivers the stimulus, WM sends the corresponding rule to the BG subsystem and the latter informs the actuators that they are supposed that they are supposed to execute the action A . It is not a very rich intelligence but for a simple air conditioner it is enough. One can imagine a richer intelligence where several rules are stored using information from different sensors as stimuli and evoking different actuators as far as response is concerned. The simple automated machine has this level of intelligence.

Technically, the system at the *Stage a* performs only “search” and “focus of attention” (select) of the GFACS package. It does not make combinations yet. This property emerges only at the *Stage b*.

Stage b (Using Rules Combinations). More sophistication is coming with an ability to “reason”, or to develop consecutive chains of rules, parallel sets of them, or consecutive-parallel combinations that lead to the goal while neither of the rules does not — if taken separately. Forming of rule combinations is a

process of grouping, and thus full package of GFACS is being performed — with the rules as a whole.

At both *Stages a* and *b* the vocabulary of sensors fully or partially coincides with the vocabulary of stimuli and the vocabulary of responses coincides with the vocabulary of actuators. The number of rules given from the beginning remains the same throughout all time span of the intelligent system functioning.

Stage c (Enhancing the Initial Set of Rules by Generalizing Upon Experiences). The system can enhance the initial set of rules by collecting experiences and transforming them into new rules. Real experiences differ from those reflected in the rules because of the errors of sensing and generating actions, because the system makes mistakes (which become a source of new information), and because it can acquire or develop a property to execute tentative (sometimes, random) actions. In other words, an ability to ask itself a question “what if”, i.e.: “What will happen if I do this action?” should gradually emerge. Then, if a system is capable of value judgment, the groups of good experiences can be collected and generalized upon (GFACS is applied) which leads to a development of a new positive rule “what to do in the case ...”. Collecting bad experiences leads to developing of new negative rules “what you should not do in the case ...”.

“What if” questions can be considered one of the form of search similar to “genetic search”. Asking the question, “what if” can have different techniques. For example, you can use so called crossover. Anyway, at the *Stage c* GSM can enhance the list of rules (and the elementary concepts it has) but it does not construct yet any new levels of resolution.

Stage d (Discovering Classes of Rules and Building New Resolution Level). When the number of rules at a level is large enough, they allow for

discovering classes that are interpreted as rules of the lower resolution level. Thus, a new (lower) level of resolution emerges; correspondingly a new level of concepts grows too, which forms a relational knowledge base for this new (lower) level of resolution. Notice, that combinatorics of grouping, focusing attention and searching is applied to the rules, and does not interfere with the vocabularies.

After the property of the *Stage d* is attained (the discovery of rule classes), the overall development ends up with the multiresolutional system of GSM, similar to the one demonstrated in Fig. 5. The algorithms of systems reproducing *Stages c* and *d* are introduced, discussed, and tested.^{35,36} The most formidable advantage of the *Stage d* in comparison with all previous stages, is the ability to construct the expression $[S_1 \rightarrow A \rightarrow S_2]_{\text{under } G}$ in which all three components G, S, and A would be multiresolutional: all loops run simultaneously at all resolution levels in different time scales. The "vertical" consistency within SP, WM and BG is to be regularly checked. Obviously, the "what if" tool of the *Stage c* in addition to forming the rule combinations from the *Stage b* are applied here too, only at all levels of resolution.

Stage e (Combinatorial Synthesis of New States and Actions). Finally, the combinatorial synthesis of states (situations) and actions is introduced.

One can easily imagine emergence of the *Stages f* and *g* with "what if" combinatorics applied to the contexts and the paradigms (*Stage f. Synthesizing Contexts, Stage g. Synthesizing Paradigms*).

Let us collect properties of stages *a* through *e* within one comparative table (Table 2). One can see from the table that the later stages of development

have all properties of preceding stages plus a new one.

One should not consider these properties to be a direct indication of the future performance of the intelligent system. Procedural capabilities of the intelligence attained by an intelligent system are not reflected in the performance directly. The character of the particular assignment is important, how prolonged in time this assignment is, how repetitive this assignment is, how much the parameters of the assignment vary from one execution to another; how structured the environment is in which the assignment is supposed to be performed; is this assignment a part of the larger paradigm where the skills acquired during the performance could be required in the future; are the unexpected factors an important issue; what is the cost-function; how much the components of the cost function are emphasized such as time, energy, monetary cost, accuracy, reliability, safety, etc.

The ability to vary the values of parameters which allows for tuning up, can be more important for the performance than acquiring of a new capability. In other words, the system belonging to a lower level of intelligence development (to a stage with less capabilities) can have better performance than the system with higher level of intelligence. This seems to be controversial but it is not. The fact is that the system with more sophistication (belonging to a stage with more capabilities) can improve its performance and eventually develop much better performance.

The following parameters would allow for tuning-up the intelligent system by changing them in all subsystems separately (SP, WM, and BG) and at all

Table 2. Properties acquired at different stages of the intelligence development.

Capability	rules selection	forming combinations	forming new rules	grouping the rules	synthesis of the states	synthesis of the context paradigm
Stages						
a	x					
b	x	x				
c	x	x	x			
d	x	x	x	x		
e	x	x	x	x	x	
f	x	x	x	x	x	x
g	x	x	x	x	x	x

levels of resolution independently:

- assigning degree of importance to the entities at hand;
- assigning the size of window in focusing attention;
- assigning of the scope of interest;
- assigning and correcting the value of resolution;
- evaluating the values of similarity, resemblance, or closeness by correcting their measures;
- evaluating the cohesiveness of groups, clusters, assemblies, and strings;
- evaluating the value of goodness for the alternatives (combinations) produce.

The rough distinction between groups of intelligent systems which is often used in discussions, recognizes levels of (1) Automation, (2) Adaptive Intelligence, and (3) Decision Supporting Intellect. Such a scale can be practically useful but is beyond the scientific endeavor.

9. Semiosis: A Perpetual Search for Meaning

Semiotics developed as a science of signs but its focus is on the mechanisms of thinking and attaining the meaning. All stages of scholarly endeavor and scientific development contributed to semiotics.^{12,39,40} The “hard” semiotics has been developed during the last 20 years. Significant contributions are linked with the name of D. Pospelov.⁴⁰ In US literature, interest is gradually growing (compare Refs. 32 and 40).

9.1. The laws of sign

The basis for the overall semiotic approach is a trilateral concept of the sign introduced by C. Peirce and illustrated in Fig. 11. The sign is understood as a unity of the label, definition, and meaning which

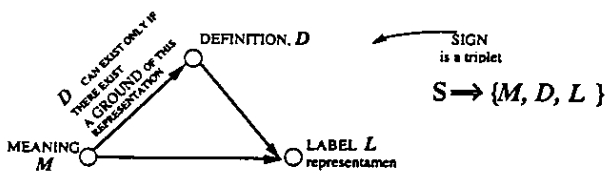

Fig. 11. The trilateral essence of a sign.

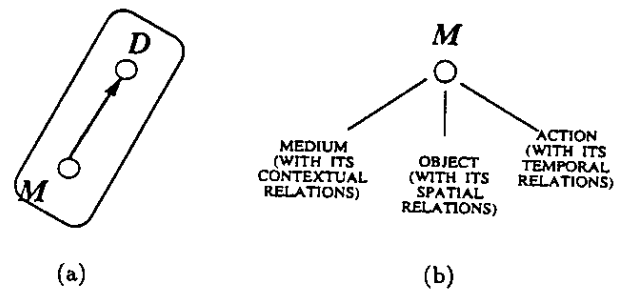

Fig. 12. The model of meaning.

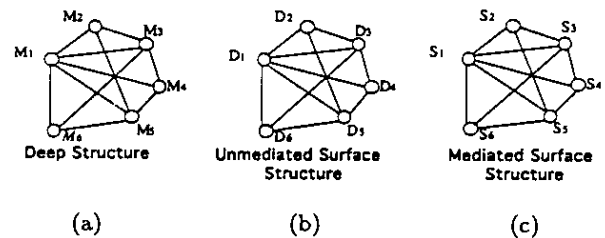

Fig. 13. Different structures components of the meaning.

should be verified throughout all discourse. (Symbol is a particular case of sign, this distinction is not discussed here).

The sign helps to recover the *interpretant* which is a couple $DU M$. *Meaning* is a unity of the attributes shown in Fig. 12. This unity provides the sign with its interpretive power.

Definition is an intersection of classes to which the meaning belongs. The definition is insufficient for arriving at the meaning because the latter can be found only as a combination of several relational networks obtained from the experience. Several relational networks jointly allow for a complete interpretation (see Fig. 13). Thus, meaning is always revealed as a result of a dynamic process of interpretation which, strictly speaking, can never be complete.

The triplet *object-sign-interpretant* is an invariance of the formalism of knowledge representation and communication. Therefore, it would not be correct to narrow the nature of semiotics to the “theory of codes”, or the “theory of sign production”.¹ This triplet allows for broad epistemological connections,

¹U. Eco, *A Theory of Semiotics*, Indiana University Press, Bloomington, IN 1976, p. 3.

deep involvement with the theory of communication, etc.

A straightforward instrumental definition of semiotics can be presented as follows:

Semiotics is a theoretical field which analyzes and develops formal tools of knowledge acquisition, representation, organization, generation and enhancement, communication, and utilization.

If one follows the set of tools in this definition, one can easily restore the structure of GSM shown in Fig. 1. There is a strong connection between this structure and the well known decomposition of semiotics into three domains: syntax, semantics, and pragmatics. This correlation can be seen from the functional diagram of the process of semiosis (see Fig. 14). The triangle of semiosis (syntax, semantics, and pragmatics) is put in correspondence with the hexagon of the Six-Box Diagram (shown in Fig. 1). It turns out that there is a direct correspondence between these two aspects of viewing the intellectual process as a whole. Let us discuss these aspects jointly.

The circulation of knowledge within the hexagon (and the triangle) shown in Fig. 4 is done by the virtue of communication which changes its incarnation from a node to a node passing through the stages of encoding, representing, organizing, interpreting, generating, applying, and transducing — all

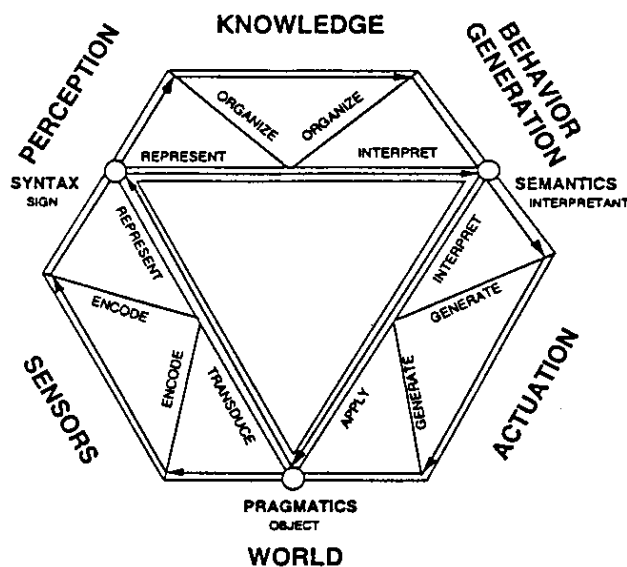

Fig. 14. The functional diagram of semiosis.

considered as different forms of communication (mappings from one language to another). As something happens in the World, it is encoded by sensors in a symbolic form and the process of representation begins. The role of Perception is to represent the results of sensing in some organized manner using signs. This process of shaping up the organization is called Syntax. It starts at this point, it continues at all subsequent stages of dealing with Knowledge while it is more and more generalized. The initial structure becomes Knowledge as the latter gets more and more generalized so that after representation is completed, interpretation is possible. Interpretation enables the process of decision making in which Semantics joints Syntax to create the *interpretant*.

The interpretant materializes in the process of Actuation, which is analogous to generation of new knowledge. As a result of this process new knowledge arrives in the World, creates changes in the World — physically and/or conceptually.^m New *objects* emerge.

In Fig. 14, a detailed, enhanced version of the Six-Box Diagram is shown. It is important to understand that in symbolic representation, the thinking process during various intelligent activities is the same in all cases of goal-oriented activities. Perception allows for recording the set of recent experiences in a symbolic form. By grouping the experiences the classes of similarity are discovered which induce hypotheses explaining these similarities, or instigate new experiences belonging to the same class of similarity.

The hypotheses enter the subsystem of Behavior Generation as a substitute for the rules, the decision for an action is made, the action is performed, changes in the world occur, the transducers (sensors) transform them into a form that can be used by Perception, and the long and complicated process of moving from signs to meaning starts again. Now, the enhanced set of experiences brings about another hypothesis which can confirm or refute the tested ones. This is when the *symbol grounding* happens.

After multiple tests, the hypotheses can cross the threshold of "trustworthiness", and a new rule is created. Among scientists, a rule (or a set of rules) within a context is considered to be "a theory". At each step of this development, the unit under

^mOne can see that "symbol grounding" is ingrained in the very concept of semiotics as a discipline.

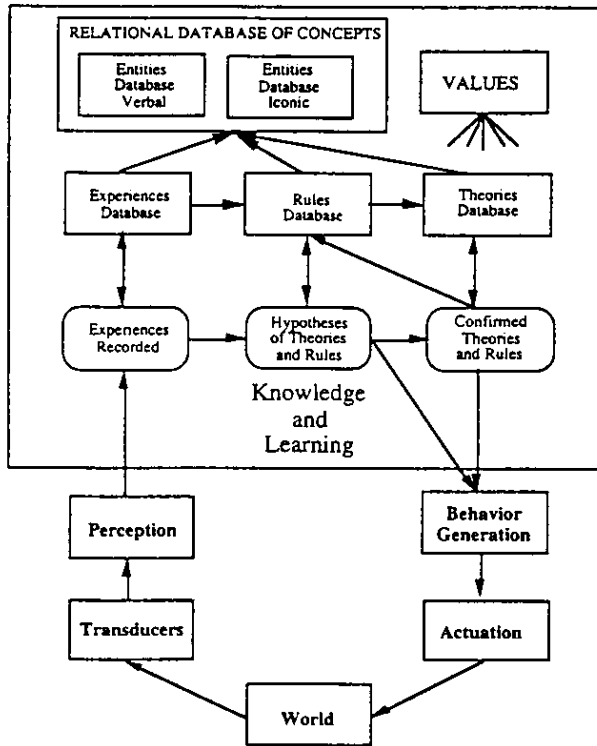

Fig. 15. Six-box diagram with learning: the cycle of semiosis.

consideration undergoes a comparison with other kindred units confined in corresponding databases (of Experiences, of Rules, and of Theories). Then the symbols tentatively assigned to some “unities”, “entities”, or “concepts” enter their place within the database of concepts (which is a relational network of symbols).

Semiosis is shown in Fig. 15. Rules (or the hypotheses which will become rules) are formed when experiences cluster together unified by their similarity. Let us denote: the prior state, S_1 ; the action that has been applied, A_1 ; the state which emerged after this, S_2 ; the value V_1 of the result.

These are the three components of experience

$$[S_1]_{E.comp1} \times [A_1]_{E.comp2} \rightarrow [S_2]_{E.comp3}, [V_1]_{E.comp3}$$

(the value V which is attached to this experience is the first basis for grouping the experiences).

Rules are formed, after some commonality in several of them is detected. They are usually presented

as inverted experiences:

$$[\text{the } V \text{ desired}]_{R.comp1} \times [\text{the state } S^* \text{ which is desired}]_{R.comp2} \times [\text{the prior state } S]_{comp3} \rightarrow [\text{the action to be applied } A]_{R.comp4}$$

An interesting and unique feature of generating rules is the following. Each component of a rule is a *generalized* component of experience. This means that in order to obtain a component of a rule, several similar components of experiences should be *ground* together into a class, a cluster. This requires applying a set of GFACS procedures. The symbol attached to this cluster signifies the process and the result of generalization. The premises behind this generalization could be different but the result will be always the same: a new class is born. If we denote the phenomenon of generalization upon i similar experiences ($i = 1, 2, \dots, n$) by a symbol \mathcal{G}_i we can write

$$[\text{the } V \text{ desired}]_{R.comp1} \rightarrow \mathcal{G}_i \{ \text{the values } V_i \text{ of the result} \},$$

$$[\text{the prior state } S]_{comp3} \rightarrow \mathcal{G}_i \{ \text{the prior states, } S_i \},$$

$$[\text{the action to be applied } A]_{R.comp4} \rightarrow \mathcal{G}_i \{ \text{the actions that has been applied } S_i \}.$$

Only the desired state is not subject to generalization; it is always individual, pertaining to a concrete situation. Nested evolution of semiosis is illustrated in Fig. 16.

The multiplicity of real cases needs to apply a variety of logical tools that has been developed for the process of semiosis. Discussion of these tools is outside of the scope of this paper. A cursory familiarity with some of them can be obtained.³⁵

We can see that the results of clustering do not belong to the list of initial words; they are generalized words. Their parameters are not as accurately defined as parameters of initial words: the parameters of generalized words are always represented as intervals which include the parameters of the initial words. This describes a process of fuzzification which happens when semiosis moves to the lower levels

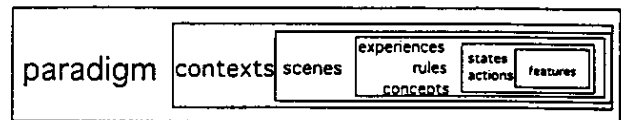

Fig. 16. Nesting during the process of semiosis.

of resolution. All levels together are to be judged from the point of view of the most generalized reference frame, which is our Natural Language.³⁶

The world of generalized words is different: it has a different resolution, coarser than the resolution of initial words. By the virtue of generalization a new, lower level of resolution was created. Nested rules and theories (rules and their contexts) are always the bridges between adjacent levels of different resolution. However, it is clear that the totality of all experiences, all theories, and all rules constitute the multiresolutional system which corresponds to the multiresolutional database of concepts which is ingrained within the body of Natural Language.

10. Reflection and Consciousness

Analysis of the Baby-Robot demonstrates that building-up the World Model starts immediately after the GSM initiates its functioning.^{37,38} However, all rules learned and concepts stored, are represented in the reference frame of the GSM (in this case — Baby-Robot). At this stage, GSM does not know that it exists as an entity: it does not need to know this, this is an original phenomenon implanted within the system of GSM flow of information. The situation changes as soon as GSM begins its search for a better path around the obstacles. Notice, that no strategy of “obstacle avoidance” is given to the Baby Robot. It is supposed to find its own strategy, and it is aware that time of the motion is a component of the measure of “goodness”: the time of the process should be reduced.

Baby-Robot contemplates the alternatives of solutions and in order to generate and compare them, Baby-Robot comes to explore a “novel” opportunity of labeling the condition part of the rules as a *variable*. Until now, the situations have not been perceived yet as variables, they were the initial and the final part of all actions. Now, the lower level of resolution enters the process of reasoning and the higher resolution “situation” can be considered a current variable, the variable of interest within the situation represented at the lower level of resolution. Baby-Robot discovers its “self” in the external word. The consciousness has emerged.

This is a very important property because it allows for performing simulation of the processes at a level as if they are viewed from the lower resolution

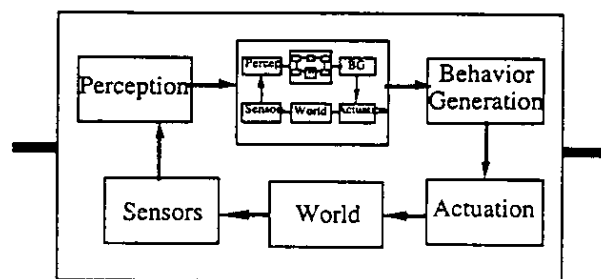

Fig. 17. Nested hierarchical reflection.

level without which the totality of the situation would not be seen.

Simulation of the world with a “self” as a part of it qualifies for being called “imagination”, indeed. In the semiotic literature, this property is called “reflection”.^{39,40}

Reflection is defined as a property of the intelligent system to represent not only the external world but also itself. Representing itself becomes a demanding feature after the “self” has already represented itself. Nestedness of representations becomes infinite which is illustrated in Fig. 17. Reflection is especially important when communication between intelligent systems is analyzed, or when the systems in conflict are under consideration.

The latter case presumes that not only the World Model of a particular GSM₁ includes representation R of the GSM (the adversary) denoted as R₁[GSM₂] but also his representation of the initial GSM₁ which can be denoted as R₂[GSM₁]. Both representations R₁[GSM₂] and R₂[GSM₁] can be called reflections of the first order. Indeed, other orders are possible since instead of the R₂[GSM₁] the adversary should better have R₂[R₁[GSM₂]], and instead of R₁[GSM₂] in the meantime, our GSM should better have R₁[R₂[GSM₁]]. Obviously, this consideration can be continued endlessly. However, multiple reflection has “blurring” effect and each new order of reflection becomes more and more fuzzified.

11. Conclusions

11.1. The meaning of intelligence

The community of intelligent control specialists always had difficulties with the term “intelligent control”. Some of the prominent specialists in

mathematical control theory were offended by the fact that when a control system follows the solution of a mathematical formalism, and this solution is bright and elegant, this system might be considered as non-intelligent. The difference seemed to be unclear between the “intelligent solution”, or “solution obtained by a highly intelligent endeavor of a scientist” and the system which produces maybe less elegant solutions but produces them based upon *its own intelligence*. We hope that as a result of this paper, the difference will be more clear between the system which *uses the intelligent solution given to it by a human* or *produces the intelligent solution with no human involvement*.

11.2. *Module of intelligence*

The phenomenon of *intelligence* emerges from functioning of an elementary package of computational routines, which performs grouping, focusing attention, and combinatorial search (GFACS) in a variety of arrangements. Functioning of GFACS is affected by a system of parameters (values) which a system should learn from its experience. Depending on the concrete system of parameters selected the results can turn out more or less competitive (adequate for the user). Most of the existing packages aspiring for the title of “intelligent” employ GFACS, or some of its components.

11.3. *Multiresolutional systems of representation*

As a result of information processing by GFACS, a set of generalized entities emerges together with relationships among them — a lower level of resolution for the same representation. If GFACS is applied to the results of its own processing (recursive processing), a multiresolutional system of representation is obtained. The latter includes as its components: a multiresolutional storage of prior experiences, a multiresolutional system of rules, and a multiresolutional system of concepts. If the memory of hereditary links is kept (memory of genesis) the multiresolutional system of representation get the properties of nestedness.

11.4. *Behavior generation*

Multiresolutional system of representation provides an efficient medium for solving problems of optimum

decision making. At lower resolution levels this requires for a simulation of future processes (*imagination* for the future decision making). The output of the Behavior Generation subsystem is a nested system of subgoals together with plans of behavior targeting the goal achievement. At the highest resolution level, it is a set of control commands.

11.5. *Degrees of intelligence*

It has been demonstrated that attainment of the capabilities of intelligence increases the complexity of problems to be solved. However, the growth of capabilities cannot be mapped directly into performance of the intelligent system. Therefore, testing the performance is not totally indicative of the level of intelligence. Testing the components of the intelligence (separate capabilities) seems to be more adequate. The power of intelligence as a whole should be evaluated by tests that challenge all components of intelligence. As a multifactor system, intelligence can be characterized only on an individual basis. How much the particular individuality fits within the paradigm of the desired performance is a different question and this question has to be resolved.

11.6. *Semiotics as a paradigm for analysis of intelligent systems*

The content and the dynamics of semiosis are shown to be in full correspondence with the functioning of intelligent system. It turns out that all critical points of the contemporary analysis of intelligence get together within this synthetic scientific discipline — semiotics.

References

1. P. J. Antsaklis and K. M. Passino, An introduction to intelligent and autonomous control (Kluwer Academic Boston, 1993) 427.
2. S. Tzafestas and H. Verbruggen, Artificial intelligence in industrial decision making, control, and automation (Kluwer Academic, Boston, 1995).
3. M. M. Gupta and N. K. Singh, Intelligent control systems: Theory and applications (IEEE Press, New York, 1995) 820.
4. D. A. White and D. A. Sofge, Handbook of intelligent control: Neural, fuzzy, and adaptive approaches, Van Nostrand Reinhold, New York, 1992, p. 568.
5. P. Antsaklis, Intelligent control, *IEEE Control Systems Magazine*, June 1994.

6. J. S. Albus, Outline for a theory of intelligence, *IEEE Trans. Systems, Man, and Cybernetics* **21**, 3 (May/June 1991) 473–509.
7. A. Meystel, Multiscale systems and controllers, *Proc. IEEE/IFAC Joint Symp. on Computer-Aided Control System Design*, Tucson, AZ, 1994, pp. 13–26.
8. J. Searle, The rediscovery of the mind (MIT Press, Cambridge, MA, 1992) 270.
9. M. Posner, Foundations of cognitive science (MIT Press, Cambridge, MA, 1989) 888.
10. J. Buchler, Philosophical writings of Peirce, Dover, New York, 1955, 386.
11. C. Peirce, Reasoning and the logic of things (Harvard University Press, Cambridge, MA, 1992) 297.
12. A. Meystel, Semiotic modeling and situation analysis: An Introduction, AdRem, Bala Cynwyd, 1995, 157.
13. M. C. Yovitz and S. Cameron, Self-organizing processes (Pergamon Press, New York, 1960).
14. A. Turing, Computing machinery and intelligence, *Mind*, 1950, 434–460.
15. J. Searle, Minds, brains, and programs, *Behavioral and Brain Sciences* **3** (1980) 417–424.
16. A. Newell, R. Young and T. Polk, The approach through symbols, ed. D. Broadbent, The simulation of human intelligence (Blackwell Publishers, 1993).
17. P. K. Wright and D. A. Bourne, Manufacturing intelligence (Addison-Wesley, Reading, MA 1988) 352.
18. J. S. Albus, Brains, behavior, and robotics, BYTE Books (McGraw Hill, Peterborough, NH, 1981) 352.
19. A. Newell, Unified theories of cognition (Harvard University Press, 1990) 549.
20. D. McFarland and T. Bossert, Intelligent behavior in animals and robots (MIT Press, Cambridge, MA 1993) 308.
21. A. Newell, Reflections on the knowledge level, *Artificial Intelligence* **59** (1993) 31–38.
22. C. Malcolm and T. Smithers, Symbol grounding via a hybrid architecture in an autonomous assembly system, ed. P. Maes, Designing autonomous agents (MIT Press, Cambridge, MA, 1990) 194.
23. S. Harnad, Symbol grounding problem, ed. S. Forrest, Emergent computation (MIT Press, Cambridge, MA, 1991) 335–346.
24. L. A. Suchman, Plans and situated actions: The problem of human-machine communication (Cambridge University Press, Cambridge UK, 1987) 203.
25. E. A. Jackson, Perspectives of nonlinear dynamics (Cambridge University Press, Cambridge, 1989).
26. V. I. Arnold, Catastrophe theory (Springer-Verlag, Berlin, 1984).
27. E. Schrödinger, Causality and wave mechanics, *Science and Humanism: Physics in Our Time*, Cambridge, 1951.
28. Y. Maximov and A. Meystel, Optimum design of multiresolutional hierarchical control systems, *Proc. IEEE Int. Symp. on Intelligent Control*, 11–13 August, 1992, Glasgow, Scotland, UK, 1992.
29. L. A. Segel, Non-linear hydrodynamic stability theory and its application to thermal convection and curved flows, eds. R. J. Donnelly, R. Herman and I. Prigogine, Non-Equilibrium thermodynamics variational techniques and stability (The University of Chicago Press, Chicago, 1966) 163–198.
30. J. Albus and A. Meystel, A reference model architecture for design and implementation of semiotic control in large and complex systems, in Architectures for semiotic modeling and situation analysis in large complex systems, *Proc. 1995 ISIC Workshop*, Monterey, CA, 1995, 33–45.
31. J. Albus and A. Meystel, Behavior generation, Technical Report, NIST, Gaithersburg, MD 1995.
32. R. M. Martin, Semiotics and linguistic structure, State University of New York Press, Albany, 1978, 321.
33. A. Meystel and M. Thomas, Computer aided conceptual design in robotics, *Proc. IEEE Int. Conf. in Robotics*, Atlanta, GA, March 13–15, 1984, 220–229.
34. A. Meystel, Planning in a hierarchical nested controller for autonomous robots, *Proc. IEEE 25th Conf. on Decision and Control*, Athens, Greece, 1986.
35. J. H. Holland, Adaptation in natural and artificial systems (MIT Press, Cambridge, MA, 1992) 211.
36. V. K. Finn, Plausible inferences and plausible reasoning, *J. Soviet Mathematics* **56**, 1, (Plenum Publishing, August 1991) 2201–2248.
37. I. B. Türksen, Knowledge representation: Linguistics to computations, *Advances in Fuzzy Theory and Technology* **2** (1994) 49–74.
38. A. Lacaze, M. Meystel and A. Meystel, Multiresolutional schemata for unsupervised learning of autonomous robots for 3D space application, *Robotics and Computer Integrated Manufacturing* **11**, 2 (1994) 53–63.
39. J. Albus, A. Lacaze and A. Meystel, Evolution of knowledge structures during the process of learning, *Proc. 1995 ISIC Workshop*, Monterey, CA, 1995, 329–335.
40. V. Lefebvre, On the self-organizing and self-reflecting systems and their research,¹ *Applied ergonomics*, a special issue on reflexive processes, **1** (1994) 6–9 (in Russian).
41. Yu. Shreider, Probabilistic interpretation of the “Formula of a Human”, *ibid.*, 20–24.
42. Yu. I. Klykov, Semiotic fundamentals of situation control, Moscow (1974) 171 (in Russian).

¹This paper was first published in Moscow, Russia, in 1965 in the materials of the conference “Problems and Research of Systems and Structures” conducted at the Academy of Sciences in Russia.

43. D. A. Pospelov, *Situation control: Theory and practice* (Nauka Publishers, 1986) (translation is available from Batelle Memorial Institute, Columbus, OH, p. 344).



A. M. Meystel is a Professor of Electrical and Computer Engineering at Drexel University. Since 1995, he is at the National Institute of Standards and Technology, on leave from Drexel University. He has developed a novel concept and outlined the theory of nested multiresolutional control systems. His concept of "Planner-Navigator-Pilot" architecture was broadly accepted in the area

of robotics in the '80s. He is the author of the book "Autonomous Mobile Robots: Vehicles with Cognitive Control" (World Scientific Publishing, 1991). He is on the editorial board of three journals in control and robotics.

Dr Meystel was an initiator of annual IEEE International Symposium on Intelligent Control, and served as general and program chairman at four out of eight Symposia since 1985. He is responsible for AI at the IEEE Technical Committee on Intelligent Control, and is the moderator of the AICS list: an electronic discussion group of Architectures for Intelligent Control Systems. He was the Chair and Co-Chair of four out of five annual IEEE Workshops on Architectures for Intelligent Control Systems. During the last three years, Dr Meystel has presented 10 National and International Invited Lectures dedicated to the design development and better understanding of the multiresolutional approach in different areas of human activity.